



INVERSIONES SantaCatalina

“Desarrollamos tus Ideas”

MARIA EUGENIA BASTARRICA

MAIL: mbastarrica@inversionesantacatalina.cl

FONOS: +56 2 25443213 o +56 9 93597687

Hang tabs autoadhesivos

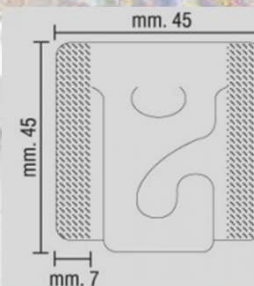
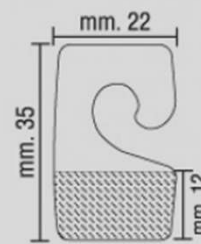
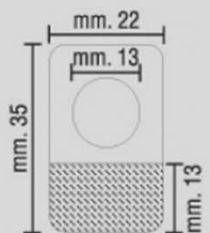
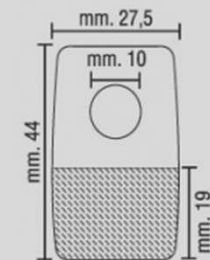
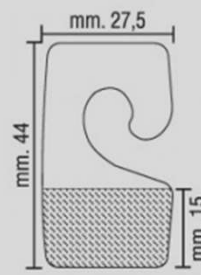
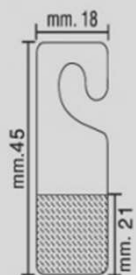
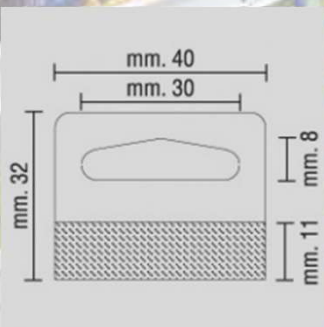
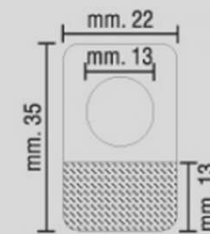
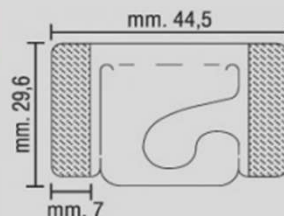
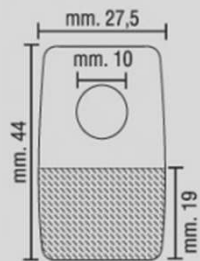
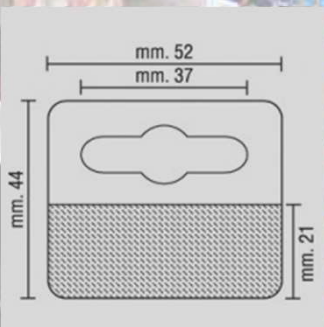

Chupones ventosas

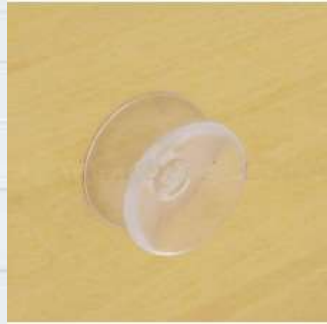
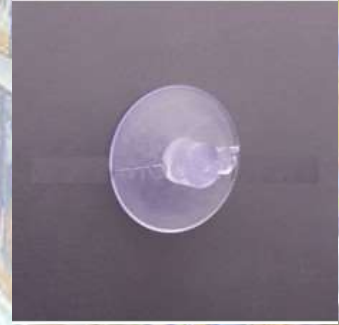
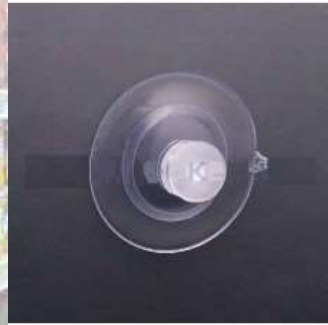

Gancheras metálicas y venta cruzada

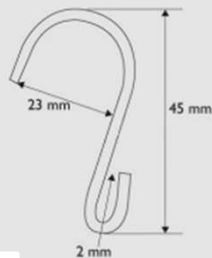
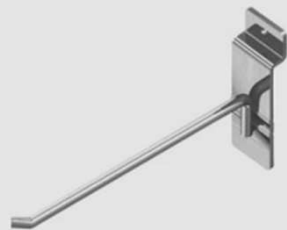
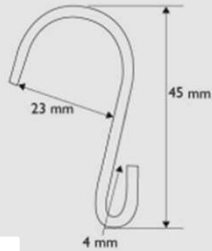
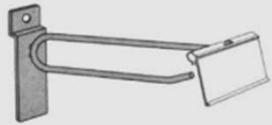

Gancheras plásticas venta cruzada

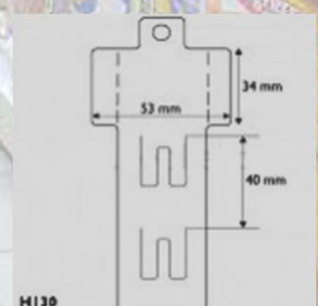
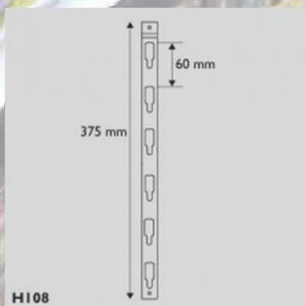
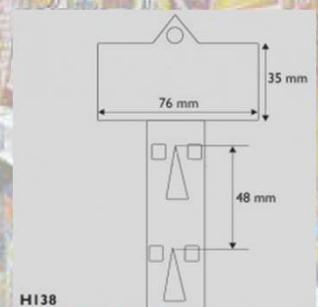
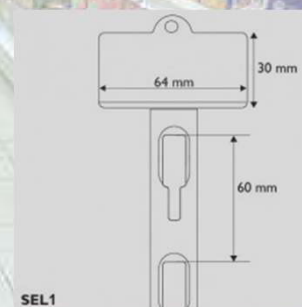
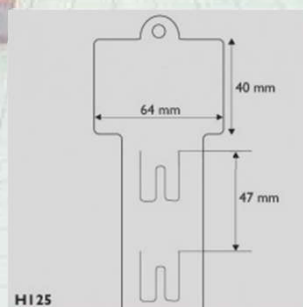
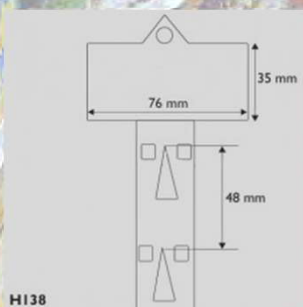
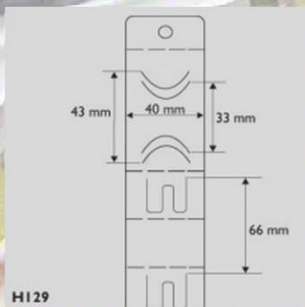
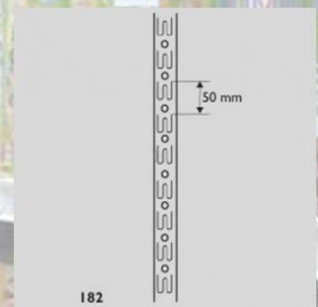
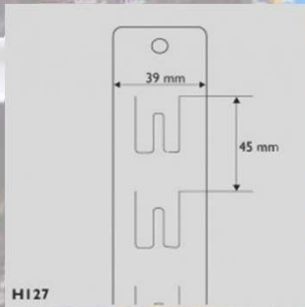

Gancheras imantadas venta cruzada



Sistema antihurto



Candados, llaves y alarmas



Pinzas, porta stopper

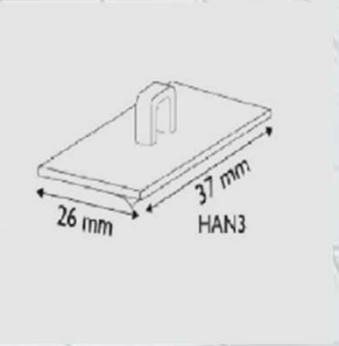
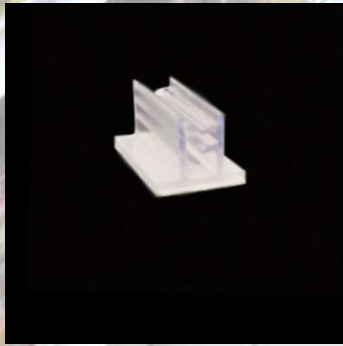
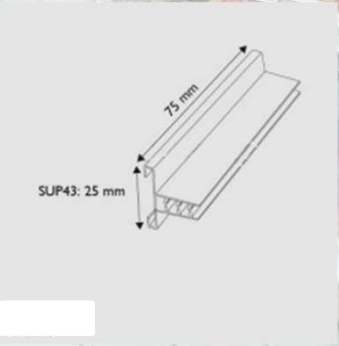
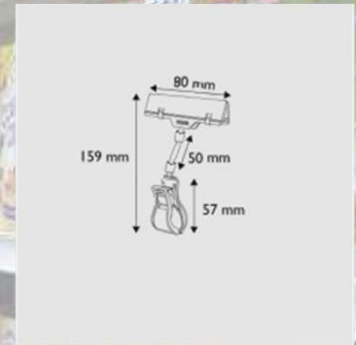
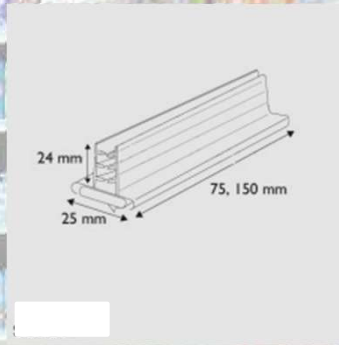
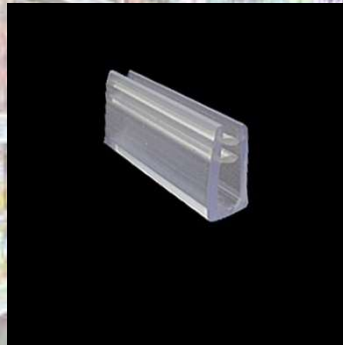
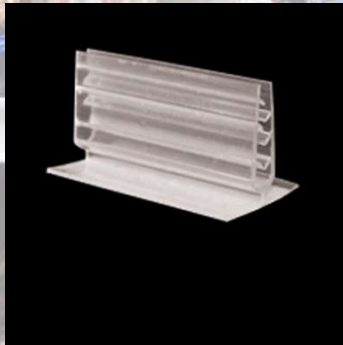

Pistola y plastiflechas

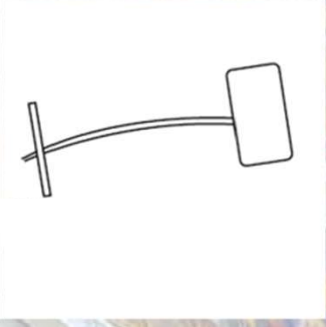
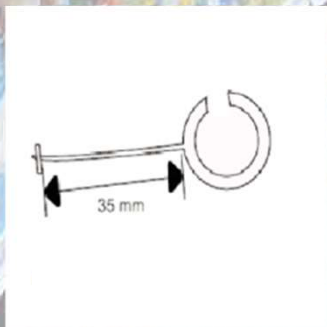
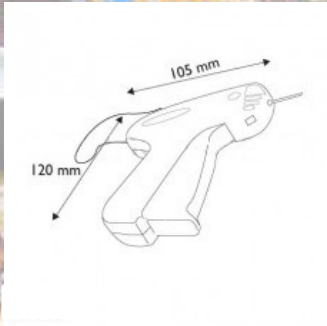

Cinta doble contacto espuma, Cintas embalaje y film stretch.



Flejeiras portaprecios

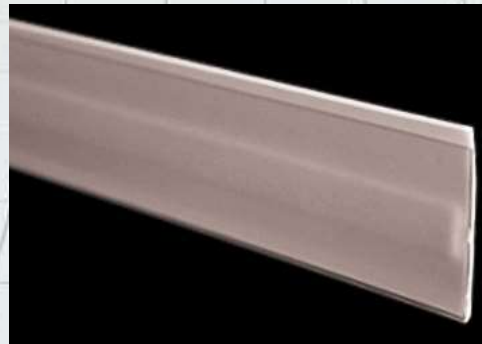
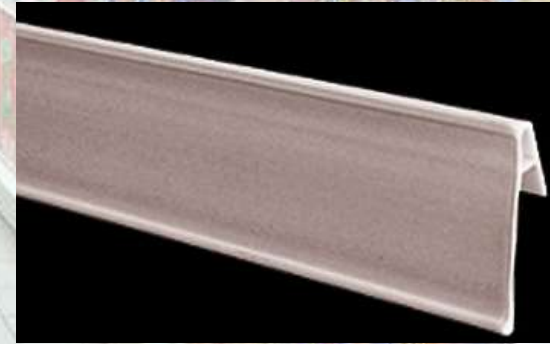
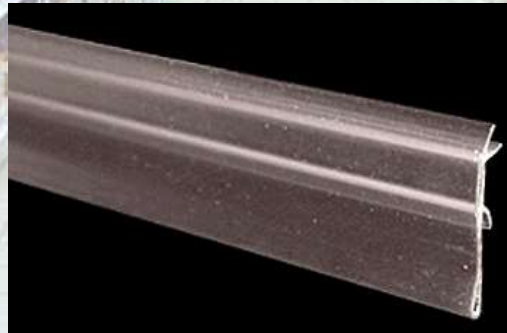
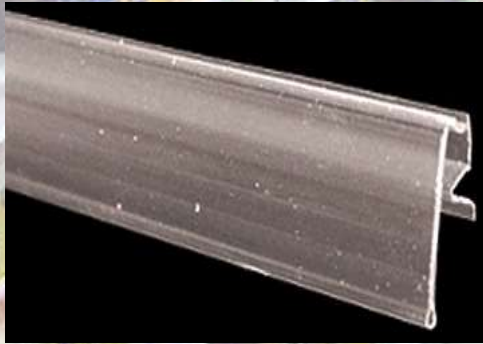
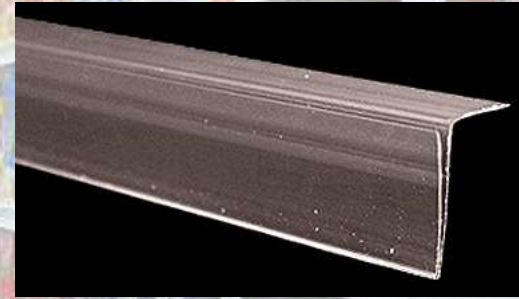
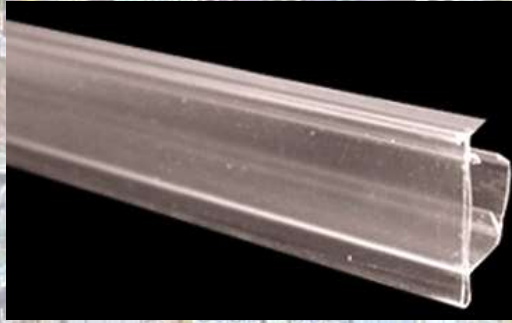
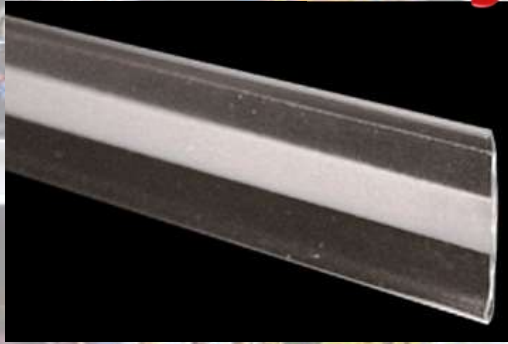

Acrílicos variados modelos



Acrílicos variados modelos



Acrílicos variados modelos

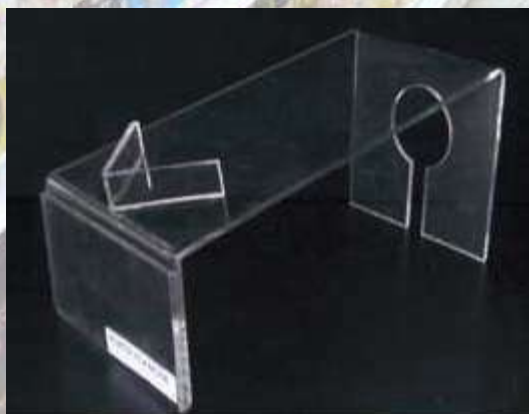

Muebles en fierro y acrílico

Mueble Para local y Góndola

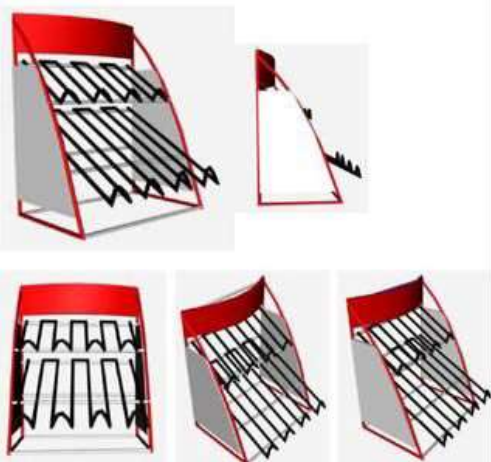

SIMPLEZA Y FUNCIONALIDAD QUE ENGANANARAN SU NEGOCIO AL MOMENTO DE LA COMPRA.

BACHA INCLINADA
Acero Inoxidable

Parachoques en PVC Plastificado.
Semi-rígido extruido antigolpes.



TERMINACIONES
metálicas entre
chapa y parachoque.



Apoyo
Caja Registradora
Enchapado melamínico

ESQUINAS
Redondeadas

ACABADOS
PINTURA: En polvo termocontráctil
híbrida (epoxi/poliéster). Horneada a 200°.

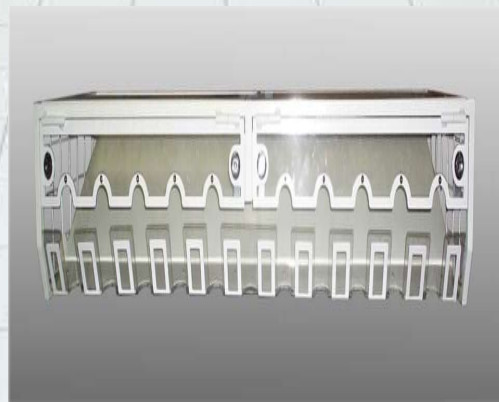

Productos metálicos

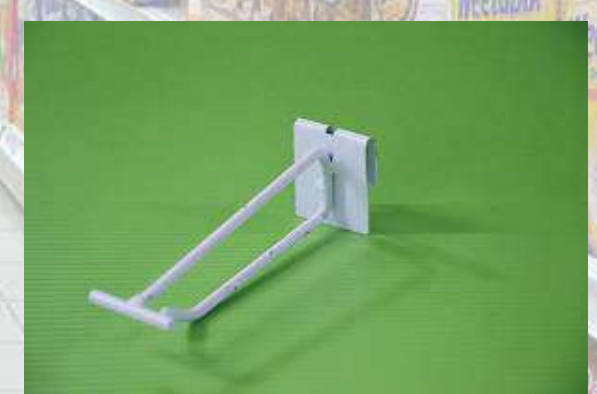
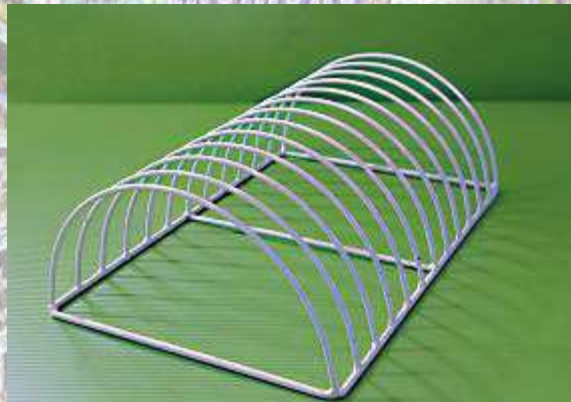

Productos metálicos



Pizarras y descriptivos



Antenas pasilleras y autosoportadas

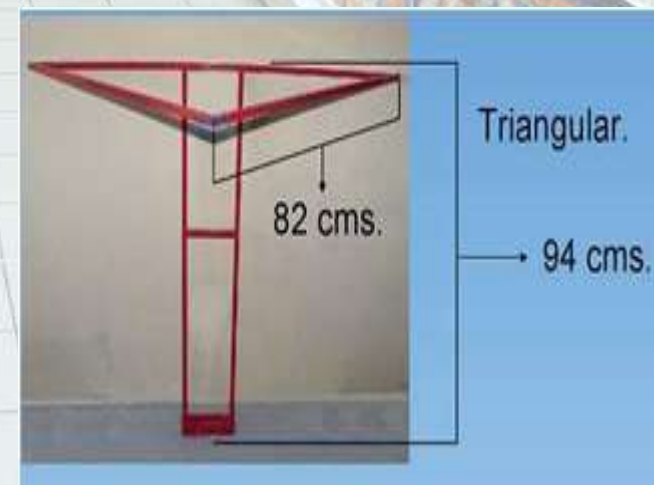
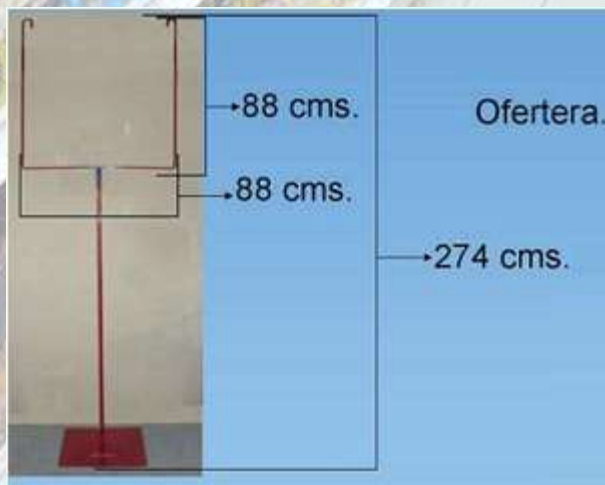
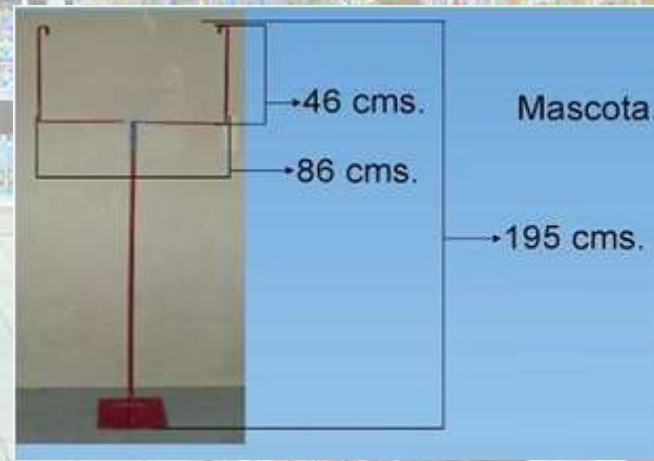
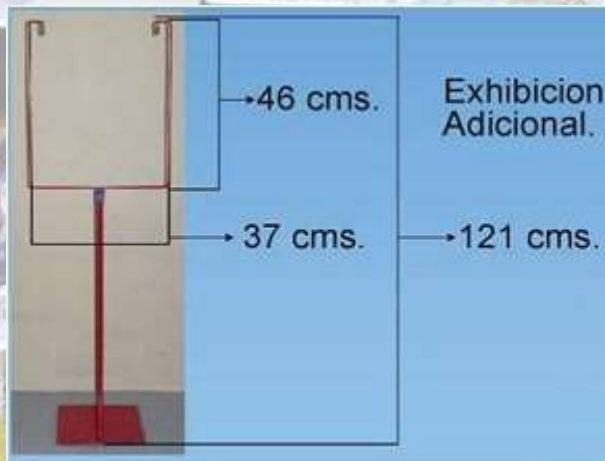

Antenas pasilleras y autosoportadas

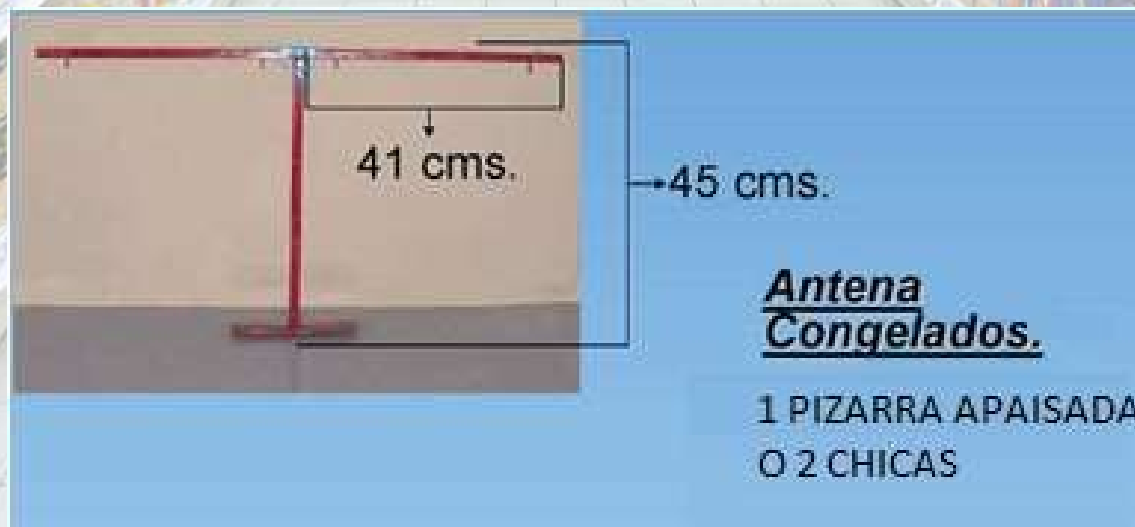
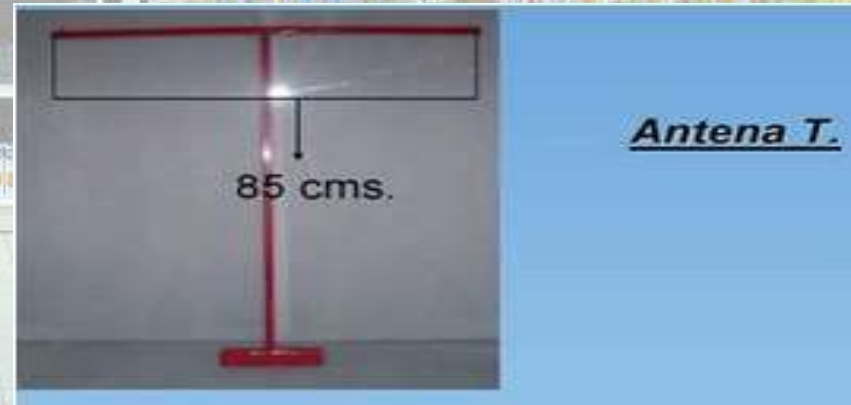
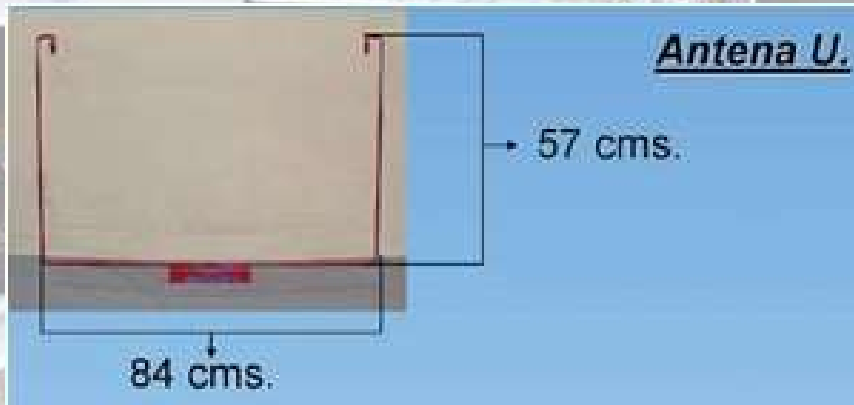

Cajas de seguridad

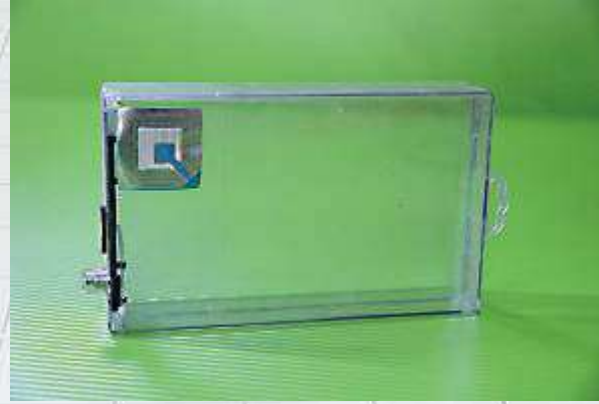

A graphic overlay featuring five white cards with blue icons: an envelope, a telephone handset, an '@' symbol, a mobile phone, and a location pin. The cards are set against a background of a supermarket aisle with shelves of products. Below the icons is a dark red rounded rectangle containing contact information.

MARIA EUGENIA BASTARRICA
mbastarrica@inversionesantacatalina.cl
+569 9359 7687